



Valex

Process Cooling Water (PCW)
Supply & Return Sticks





PCW Return & Supply Stick



Process Cooling Water (PCW) sticks are used to control cooling water for critical process equipment. Heat is enemy number one in demanding industrial production environments, so maintaining optimal process temperatures is vital for successful production. Our supply and return sticks are sized to offer low-pressure drop, while maintaining accurate flow measurement and control. Compact footprints and a variety of end connections make for easy installation. Valex PCW sticks feature robust construction, value, and reliability that we put our name behind.

Features & Benefits

- Supply sticks with Ball Valve and Pressure Regulator for precise pressure control and shutoff
- Return sticks with high-efficiency globe valve for precise flow control and flowmeters with GPM and LPM scales.
- 100% factory assembled and hydrostatically leak tested
- Individually bagged
- Simplified installation with space-efficient footprints, and end-connection flexibility

Product Description

Media Compatibility	Process Cooling Water (PCW)
Size Range	1/2 – 2
Configurations	Supply Stick Assembly Return Stick Assembly Component Device Only
End Connections	
Sizes:	1/4" – 2" NPS 1/2 – NPS 2
Types:	NPT/FNPT Hose Barb Extended Hose Barb Compression Extended Union



Supply Stick



Dimensions

FNPT X FNPT

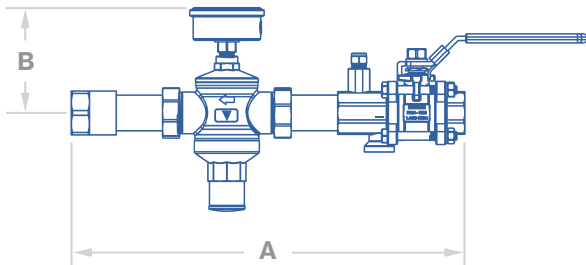

Dimensions Listed as Millimeters

Connection Size (Inlet X Outlet)	Valve Size	A	B
1/2 X 1/2	1/2	312.9	79.1
3/4 X 3/4	3/4	325.3	79.1
1 X 1	1	367.9	97.3
1-1/2 X 1-1/2	1-1/2	400.0	100.3
2 X 2	2	430.7	104.3

MNPT X MNPT

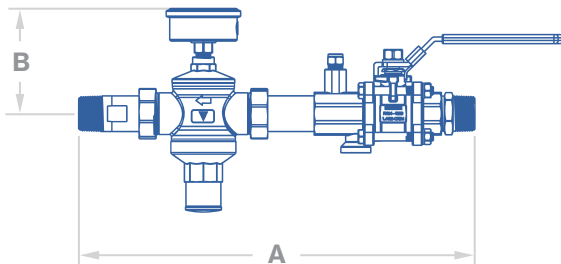

Dimensions Listed as Millimeters

Connection Size (Inlet X Outlet)	Valve Size	A	B
1/2 X 1/2	1/2	316.2	79.1
3/4 X 3/4	3/4	327.5	79.1
1 X 1	1	370.5	97.3
1-1/2 X 1-1/2	1-1/2	402.0	100.3
2 X 2	2	432.2	104.3

* Dimensions are approximate and may vary on each PCW assembly.



COMPRESSION X COMPRESSION

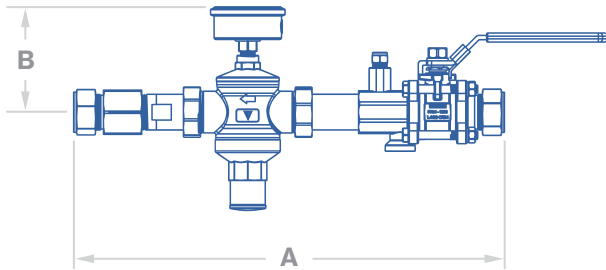

Dimensions Listed as Millimeters

Connection Size (Inlet X Outlet)	Valve Size	A	B
1/2 X 1/2	1/2	331.0	79.1
3/4 X 3/4	3/4	346.5	79.1
1 X 1	1	402.8	97.3
1-1/2 X 1-1/2	1-1/2	505.4	100.3
2 X 2	2	574.2	104.3

HOSE BARB X HOSE BARB

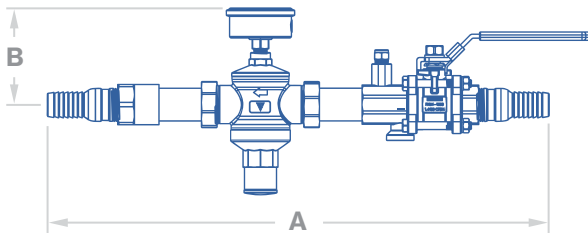

Dimensions Listed as Millimeters

Connection Size (Inlet X Outlet)	Valve Size	A	B
3/8 X 3/8	1/2	389.8	79.1
1/2 X 1/2	1/2	398.7	79.1
3/4 X 3/4	3/4	439.5	79.1
1 X 1	1	482.4	97.3
1-1/2 X 1-1/2	1-1/2	576.2	100.3
2 X 2	2	631.4	104.3

EXTENDED UNION X EXTENDED UNION

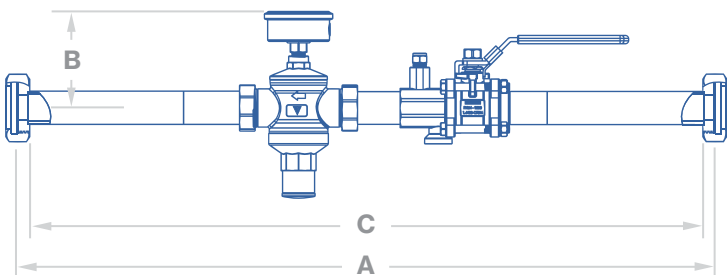

Dimensions Listed as Millimeters

Connection Size (Inlet X Outlet)	Valve Size	A	B	C
1/2 X 1/2	1/2	687.1	79.1	663.0
3/4 X 3/4	3/4	705.8	79.1	618.8
1 X 1	1	709.9	97.3	686.0
1-1/2 X 1-1/2	1-1/2	714.9	100.3	690.0
2 X 2	2	711.0	104.3	686.0

* Dimensions are approximate and may vary on each PCW assembly.



EXTENDED HOSE X EXTENDED HOSE

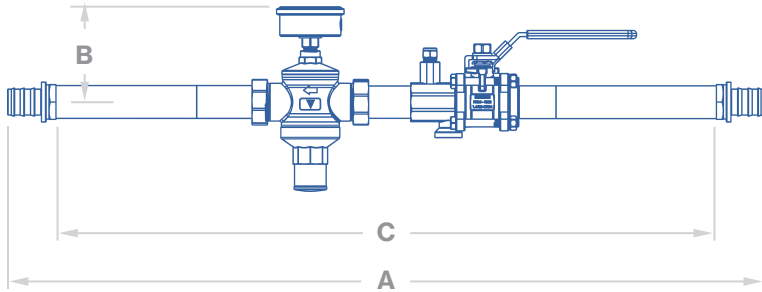

Dimensions Listed as Millimeters

Connection Size (Inlet X Outlet)	Valve Size	A	B	C
1/4 X 1/4	1/2	720.5	79.1	667.1
3/8 X 3/8	1/2	728.1	79.1	667.1
1/2 X 1/2	1/2	737.1	79.1	667.1
3/4 X 3/4	3/4	767.2	79.1	665.8
1 X 1	1	766.7	97.3	670.0
1-1/2 X 1-1/2	1-1/2	832.9	100.3	686.7
2 X 2	2	858.7	104.3	685.9

EXTENDED HOSE X EXTENDED HOSE
(Regulator Port Option D Only)

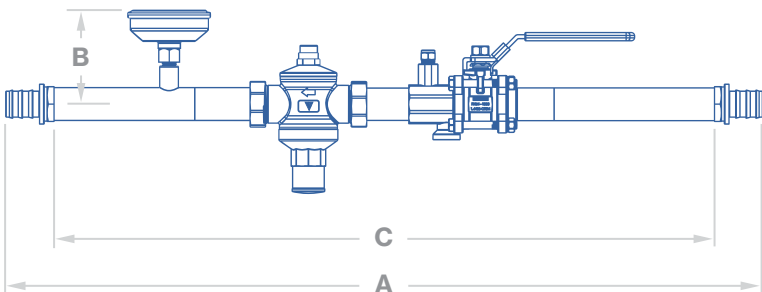

Dimensions Listed as Millimeters

Connection Size (Inlet X Outlet)	Valve Size	A	B	C
1/4 X 1/4	1/2	720.5	90.3	667.1
3/8 X 3/8	1/2	728.1	90.3	667.1
1/2 X 1/2	1/2	737.1	90.3	667.1
3/4 X 3/4	3/4	767.2	90.3	665.8
1 X 1	1	766.7	94.8	670.0
1-1/2 X 1-1/2	1-1/2	832.9	101.2	686.7
2 X 2	2	858.7	103.2	685.9

EXTENDED HOSE X EXTENDED HOSE
(Ball Valve Only)

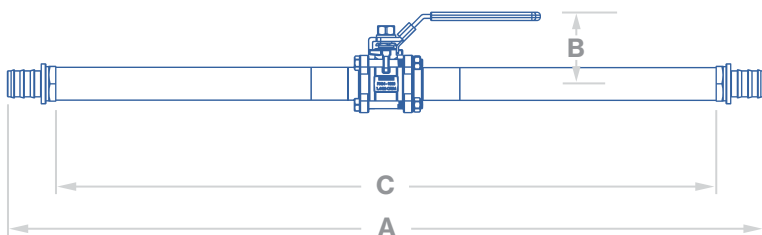

Dimensions Listed as Millimeters

Connection Size (Inlet X Outlet)	Valve Size	A	B	C
1/4 X 1/4	1/2	738.8	58.4	685.4
3/8 X 3/8	1/2	746.4	58.4	685.4
1/2 X 1/2	1/2	755.4	58.4	685.4
3/4 X 3/4	3/4	776.4	64.5	675.0
1 X 1	1	778.8	74.0	682.0
1-1/2 X 1-1/2	1-1/2	840.0	90.8	693.8
2 X 2	2	864.0	99.0	691.2

* Dimensions are approximate and may vary on each PCW assembly.



Return Stick



Dimensions

FNPT X FNPT

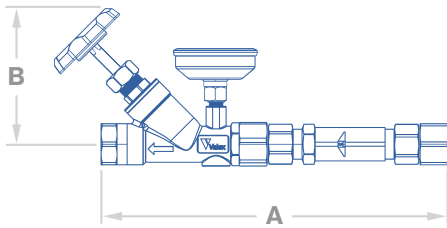

Dimensions Listed as Millimeters

Connection Size (Inlet X Outlet)	Valve Size	A	B	
			Open Valve	Closed Valve
1/2 X 1/2	1/2	308.0	101.5	94.5
3/4 X 3/4	3/4	324.0	113.5	102.2
1 X 1	1	347.0	134.5	121.3
1-1/2 X 1-1/2	1-1/2	440.6	158.2	137.7
2 X 2	2	470.6	181.7	156.6

MNPT X MNPT

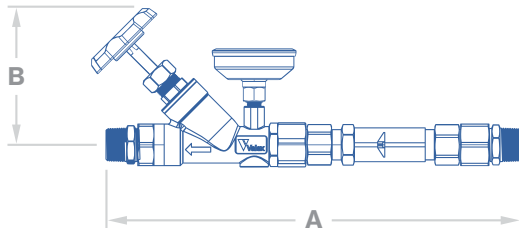

Dimensions Listed as Millimeters

Connection Size (Inlet X Outlet)	Valve Size	A	B	
			Open Valve	Closed Valve
1/2 X 1/2	1/2	366.6	101.5	94.5
3/4 X 3/4	3/4	382.4	113.5	102.2
1 X 1	1	410.0	134.5	121.3
1-1/2 X 1-1/2	1-1/2	508.7	158.2	137.7
2 X 2	2	541.5	181.7	156.6

* Dimensions are approximate and may vary on each PCW assembly.



COMPRESSION X COMPRESSION

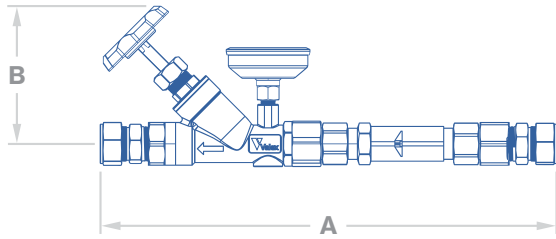

Dimensions Listed as Millimeters

Connection Size (Inlet X Outlet)	Valve Size	A	B	
			Open Valve	Closed Valve
1/2 X 1/2	1/2	382.0	101.5	94.5
3/4 X 3/4	3/4	397.2	113.5	102.2
1 X 1	1	439.6	134.5	121.3
1-1/2 X 1-1/2	1-1/2	583.7	158.2	137.7
2 X 2	2	660.0	181.7	156.6

HOSE BARB X HOSE BARB

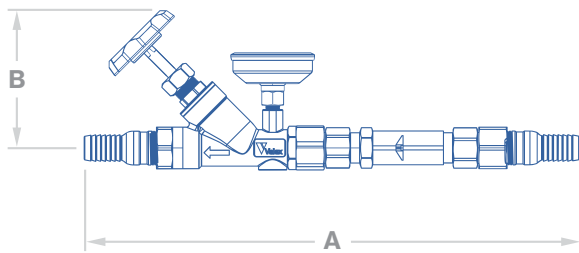

Dimensions Listed as Millimeters

Connection Size (Inlet X Outlet)	Valve Size	A	B	
			Open Valve	Closed Valve
3/8 X 3/8	1/2	385.0	101.5	94.5
1/2 X 1/2	1/2	393.8	101.5	94.5
3/4 X 3/4	3/4	438.2	113.5	102.2
1 X 1	1	464.2	134.5	121.3
1-1/2 X 1-1/2	1-1/2	616.9	158.2	137.7
2 X 2	2	671.3	181.7	156.6

EXTENDED UNION X EXTENDED UNION

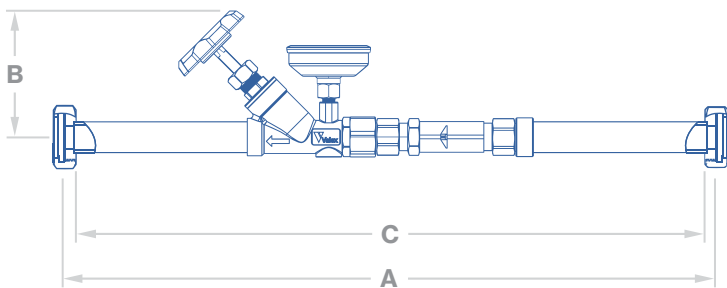

Dimensions Listed as Millimeters

Connection Size (Inlet X Outlet)	Valve Size	A	B		C
			Open Valve	Closed Valve	
1/2 X 1/2	1/2	700.00	101.5	94.5	676.0
3/4 X 3/4	3/4	702.0	113.5	102.2	678.0
1 X 1	1	706.0	134.5	121.3	682.0
1-1/2 X 1-1/2	1-1/2	699.6	158.2	137.7	676.7
2 X 2	2	714.6	181.7	156.6	688.0

* Dimensions are approximate and may vary on each PCW assembly.



EXTENDED HOSE X EXTENDED HOSE

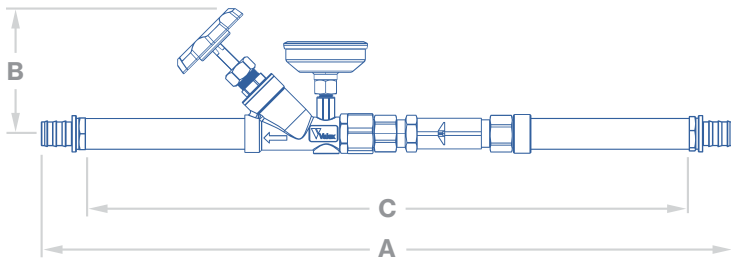

Dimensions Listed as Millimeters

Connection Size (Inlet X Outlet)	Valve Size	A	B		C
			Open Valve	Closed Valve	
3/8 x 3/8	1/2	741.0	101.5	94.5	680.0
1/2 X 1/2	1/2	740.0	101.5	94.5	670.0
3/4 X 3/4	3/4	763.4	113.5	102.2	662.0
1 X 1	1	762.8	134.5	121.3	666.0
1-1/2 X 1-1/2	1-1/2	809.6	158.2	137.7	663.4
2 X 2	2	860.6	181.7	156.6	687.8

EXTENDED HOSE X EXTENDED HOSE

(Flowmeter Option A Only)

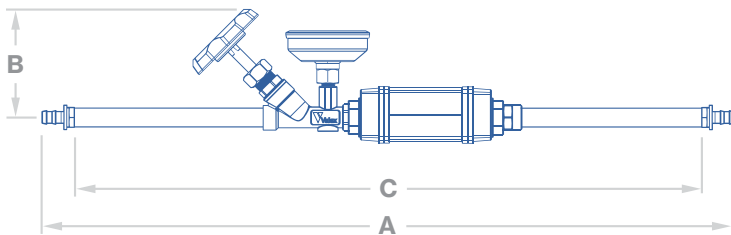

Dimensions Listed as Millimeters

Connection Size (Inlet X Outlet)	Valve Size	A	B		C
			Open Valve	Closed Valve	
1/4 x 1/4	1/2	725.4	101.5	94.5	670.0
3/8 x 3/8	1/2	751.0	101.5	94.5	690.0
1/2 X 1/2	1/2	750.0	101.5	94.5	680.0

EXTENDED HOSE X EXTENDED HOSE

(No Flowmeter)

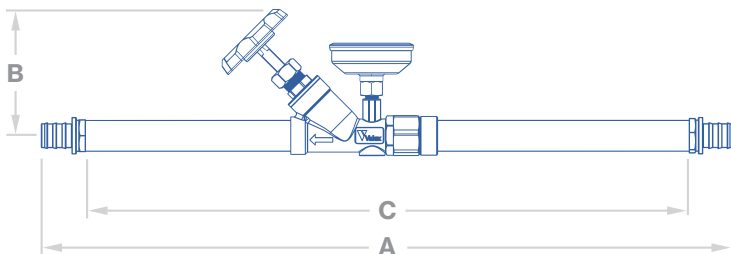

Dimensions Listed as Millimeters

Connection Size (Inlet X Outlet)	Valve Size	A	B		C
			Open Valve	Closed Valve	
1/2 X 1/2	1/2	740.0	101.5	94.5	670.0
3/4 x 3/4	3/4	769.4	113.5	102.2	668.0
1 x 1	1	775.8	134.5	121.3	679.0
1-1/2 x 1-1/2	1-1/2	830.0	158.2	137.7	683.8
2 x 2	2	859.0	181.7	156.6	686.2

* Dimensions are approximate and may vary on each PCW assembly.



Globe Valve

Product Description

- Size Range: 1/2 thru 2
- Maximum Working Pressure: 350 PSIG (24.1 BARG)
- Temperature Range: 0°F to 350°F (-20°C to 176°C)
- Integrated NPT port for installation of gauge or sensor.

Materials of Construction

Part	Material
Wetted Path	CF8M/304/316 stainless steel
Disc/seals	Polytetrafluoroethylene (PTFE)

Flow Coefficient

Valve Size	Cv
1/2	7.4
3/4	13.0
1	18.5
1-1/2	48.3
2	79.9

Flow Coefficient (Cv) per ANSI/ISA S75.02



FLOWMETER

Product Description

- Orientation: Vertical or Horizontal Installation
- Measuring Principle: Spring Loaded Float

Materials of Construction

Component	Material
Body / Poppet	Polysulfone
O-ring Seals	Nitrile NBR
Spring / Retainer	300 Series Stainless

Performance Specification

Max Operating Pressure

250 PSI (17.2 BAR)

Operating Temperature

250°F Max (121°C Max)

Size Range: 1/2 - 1

0.5 – 5.0 GPM / 2 – 20 LPM
 1 – 16 GPM / 5 – 60 LPM
 3 – 28 GPM / 10 – 110 LPM

Size Range: 1-1/2 - 2

3 – 28 GPM / 10 – 110 LPM
 5 – 50 GPM / 20 – 200 LPM
 10 – 100 GPM / 40 – 400 LPM

Accuracy Scale

±5% of Full

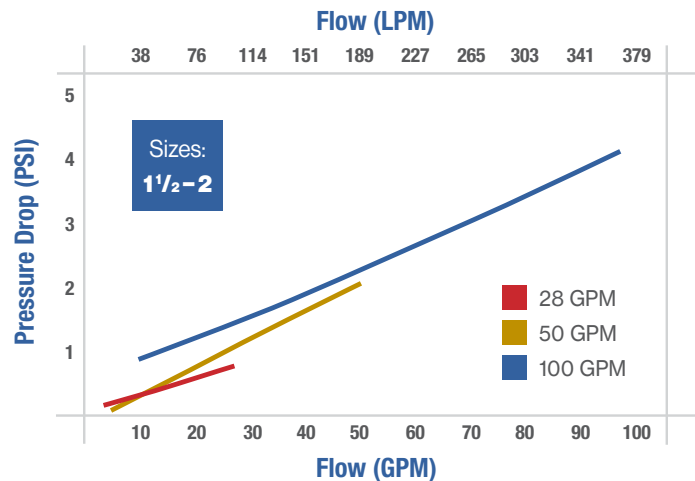
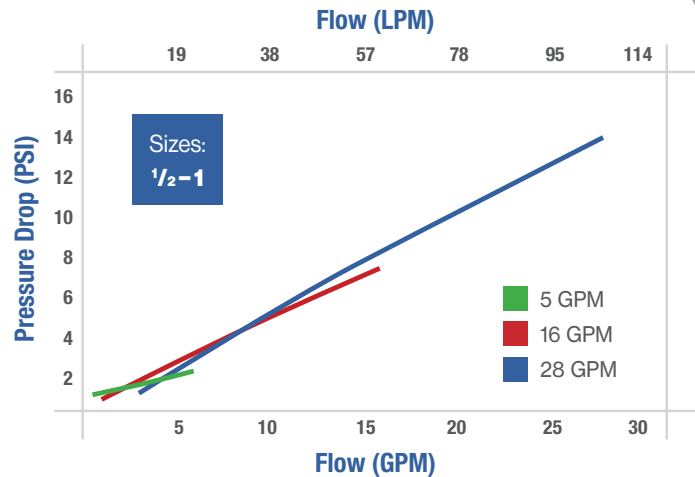

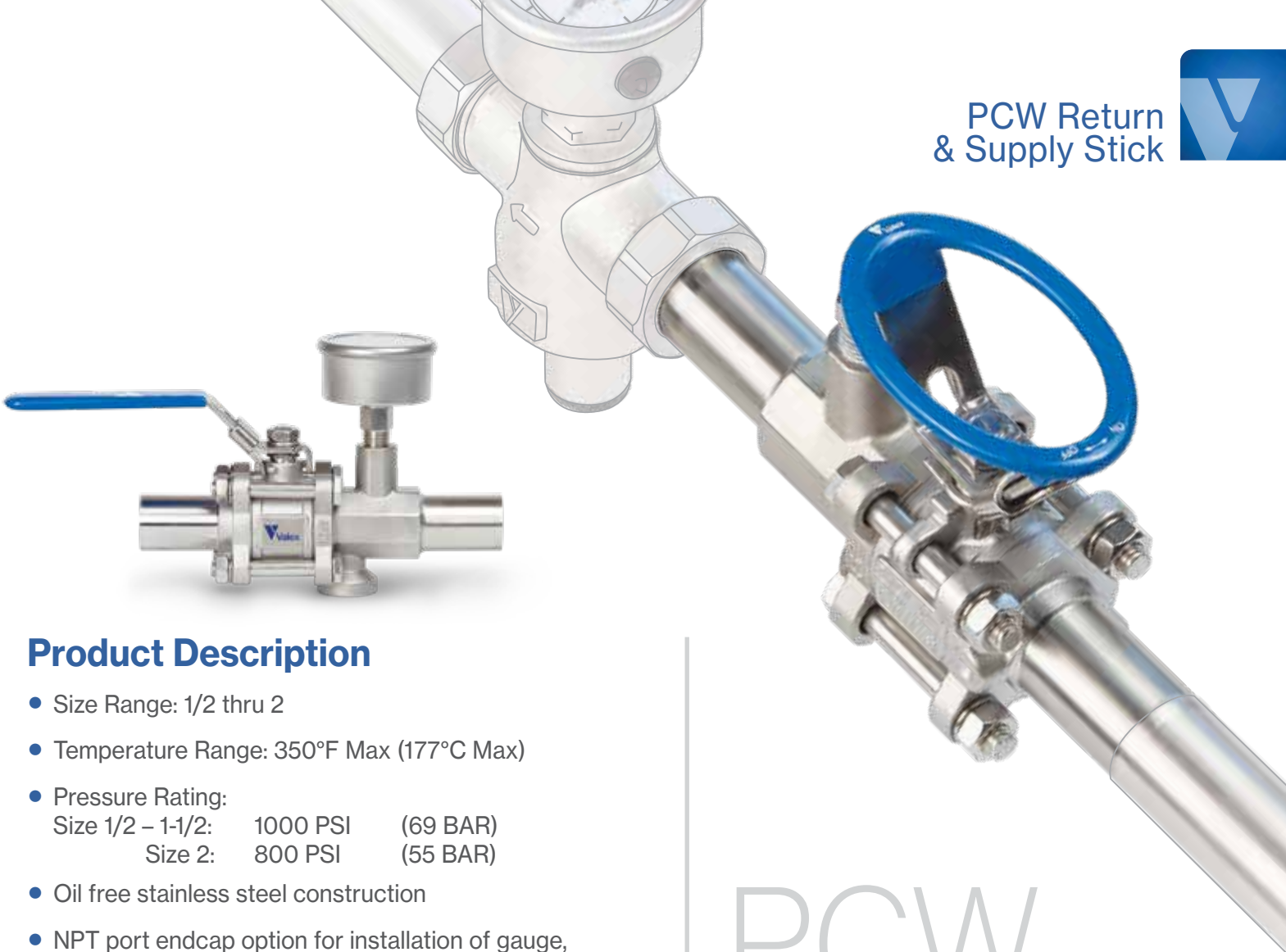

Product Description

- Size Range: 1/2 thru 2
- Temperature Range: 350°F Max (177°C Max)
- Pressure Rating:
 - Size 1/2 – 1-1/2: 1000 PSI (69 BAR)
 - Size 2: 800 PSI (55 BAR)
- Oil free stainless steel construction
- NPT port endcap option for installation of gauge, Petes Plug™ or sensor.

Pressure Temperature Rating

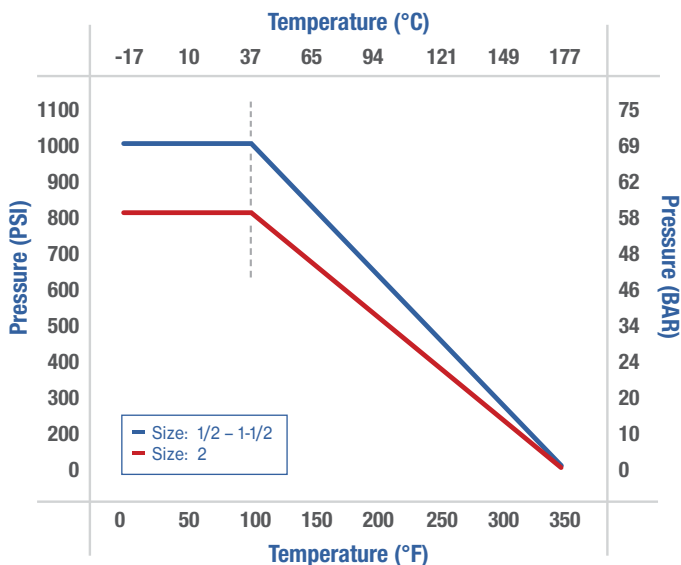

PCW Valve

Flow Coefficient

Valve Size	Cv
1/2	17.7
3/4	38.2
1	65.9
1-1/2	114.2
2	116.5

Flow coefficient (Cv) per ANSI/ISA S75.02

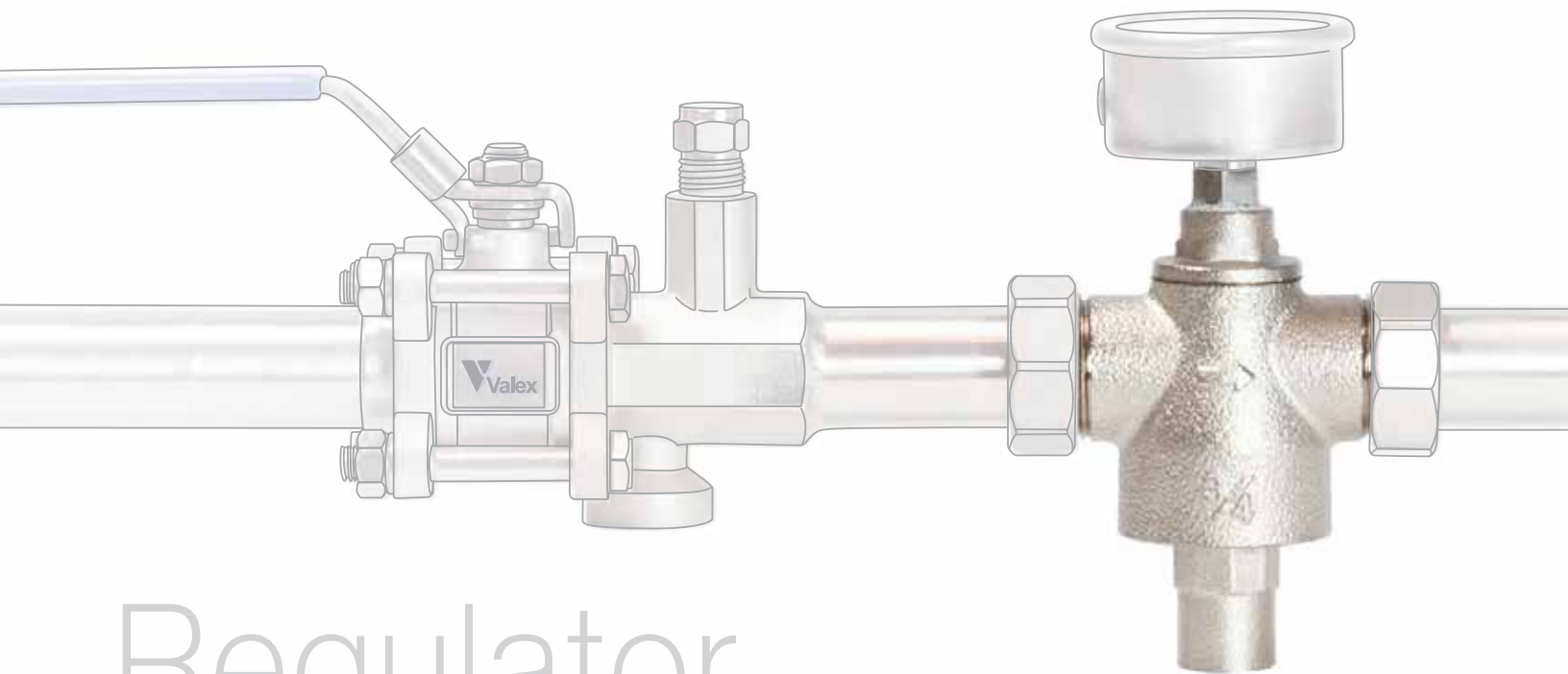

Regulator

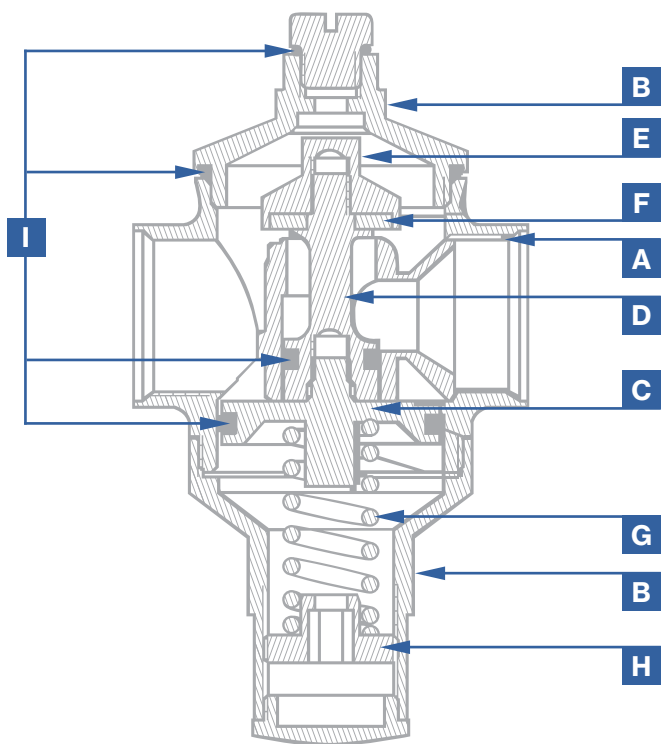

Materials of Construction

Item	Part	Material
A	Body I.D./O.D.	Nickel Plated ASTM C84400
B	Cage I.D./O.D.	Nickel Plated JIS C3604
C	Piston	300 Series Stainless
D	Stem	300 Series Stainless
E	Disk Holder	300 Series Stainless
F	Disk	NBR
G	Spring	SWPA
H	Adjusting Screw	Nickel Plated JIS C3604
I	O-ring	NBR



Performance Specification

Max Operating Temperature	158°F max (70°C max)
Maximum Inlet Pressure	213 PSI (14.7 BAR)
Outlet Pressure Range	10 – 100 PSI (0.7 – 6.9 BAR)

Regulator Pressure Curve

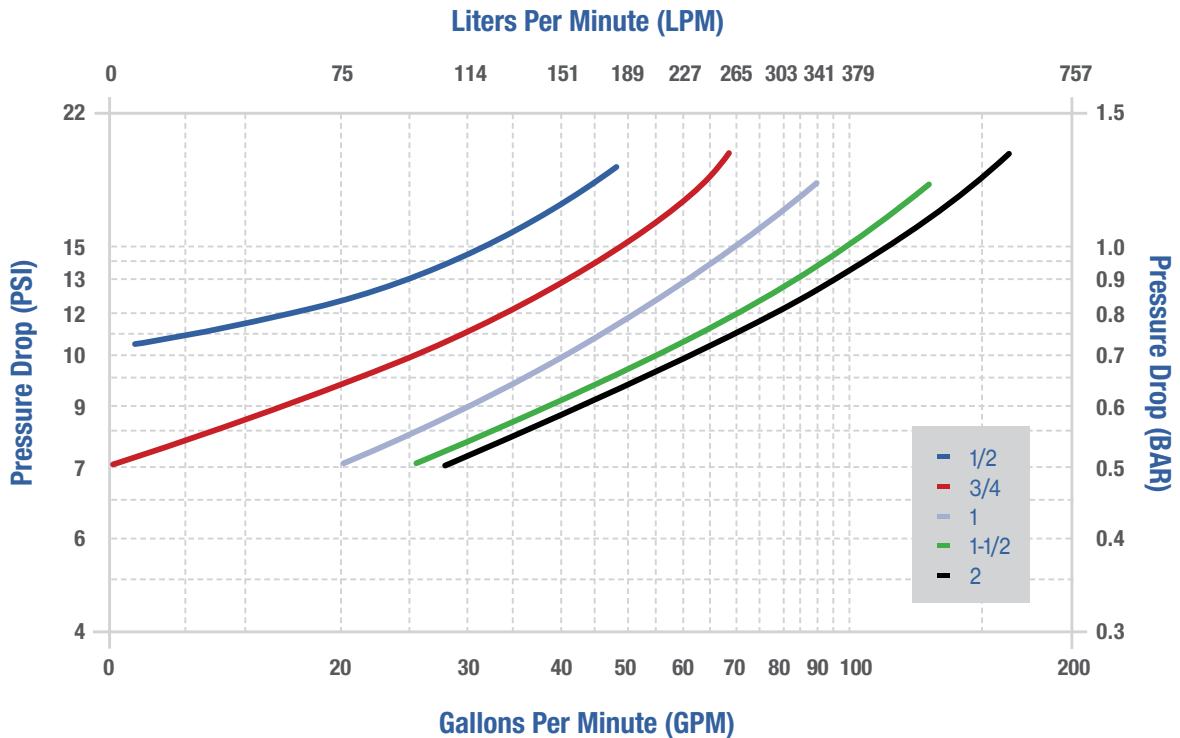



Dual Gauge
(Temp & Pressure)

NPT Port Options



Pressure Gauge



NPT Plug
for future expansion



Pete's Plug®
for quick temperature and pressure readings

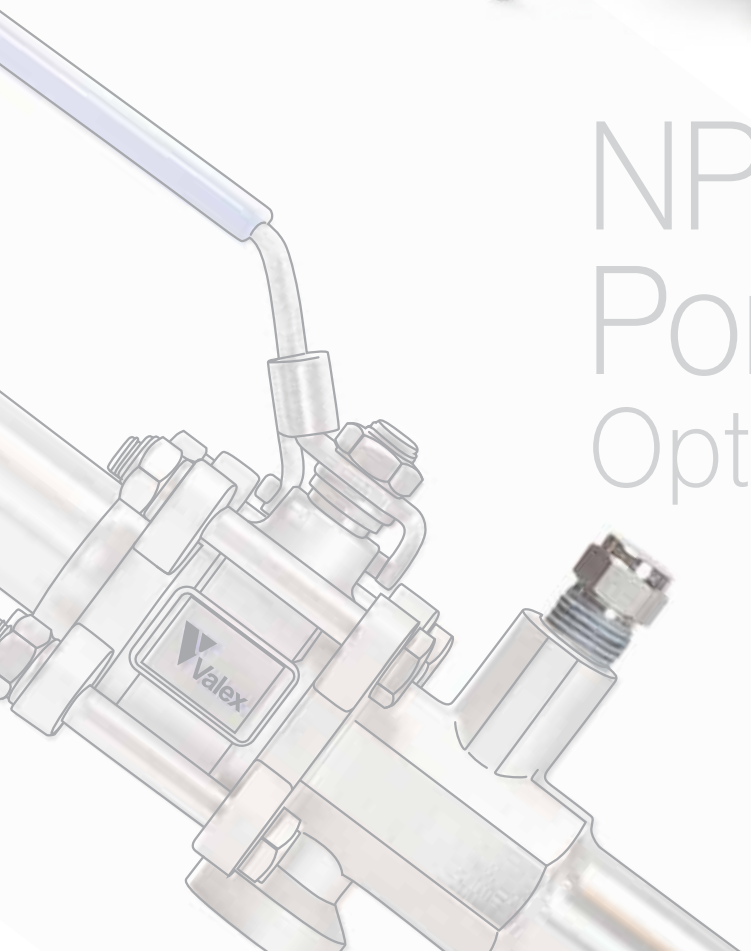

Pressure Gauge Specification

Dual Gauge

Enclosure Rating	IP65
Connection	NPT 1/4 Male Thread
Pressure Range	0 to 120 PSIG (0 to 8 BARG)
Pressure Accuracy	± 3% of Full Scale
Temperature Rating	0 to 140 °F (-20 ° to 60 °C)
Temperature Accuracy	± 3% of Full Scale
Gauge Size	63mm Diameter
Case Material	304 SS
Bezel Material	Glass

Pressure Gauge

Enclosure Rating	IP65
Connection	NPT 1/4 Male Thread
Pressure Range	0 to 120 PSIG (0 to 8 BARG)
Pressure Accuracy	± 3% of Full Scale
Gauge Size	52mm Diameter
Case Material	304 SS
Bezel Material	Glass

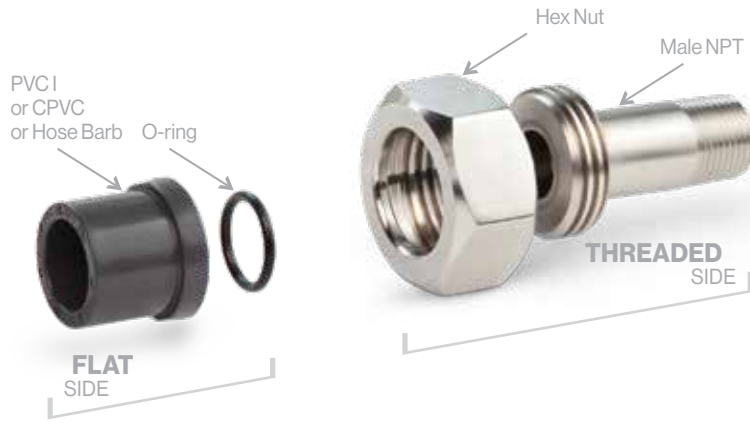

Unions

Materials of Construction

Item	Part	Material
A	Socket Weld Ferrule	PVC I or CPVC
B	O-ring	Nitrile Rubber
C	Hex Nut	300 Series Stainless
D	"Thread" Side	300 Series Stainless
E	Hose Barb	300 Series Stainless

PCW Union Fitting Ordering Information¹

W U - U - 1 6 P - 1 6 M

W U

Product Line
WU = PCW Unions

1 | 6

"Thread" Size

- XX = None
- 04 = 1/4
- 06 = 3/8
- 08 = 1/2
- 12 = 3/4
- 16 = 1
- 24 = 1-1/2
- 32 = 2

U

Union Type
U = Standard
V² = Compact

1 | 6

"Flat" Size

- XX = None
- 04 = 1/4
- 06 = 3/8
- 08 = 1/2
- 12 = 3/4
- 16 = 1
- 24 = 1-1/2
- 32 = 2

M

"Thread" Side Assembly

- X³ = None
(No Thread Side, No Hex Nut)
- M = Male NPT
- S = NPS Pipe
- T = Tube

P

"Flat" Side Assembly

- X = None
(No Flat Side)
- P = PVC I
- C = CPVC
- H = Hose Barb
- S = NPS Pipe
- T = Tube

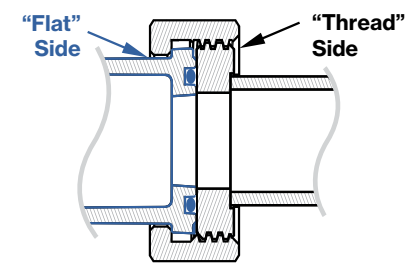
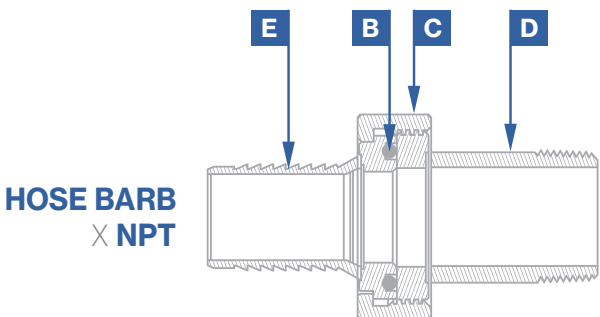
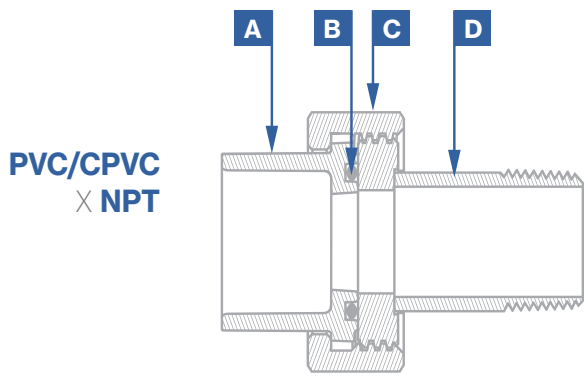

¹ Not all possible part number configurations are available. Please contact Valox for availability.
² Compact Union Type: used only for stainless steel "Flat" assembly end connection options.

³ No thread side, no hex nut option: used on PCW sticks which already contain compatible mating ends.



Vertical Flowmeter

Product Description

- Orientation: Vertical Installation
- Measuring Principle: Float

Materials of Construction

Component	Material
Body	Polysulfone
O-ring Seals	Nitrile NBR
Float	300 Series Stainless

Performance Specification

Max Operating Pressure

250 PSI (17.2 BAR)

Operating Temperature

250°F Max (121°C Max)

Size Range: 1/2

1 – 10 GPM / 5 – 38 LPM

Size Range: 3/4 – 1

1 – 10 GPM / 4 – 40 LPM
2 – 20 GPM / 8 – 80 LPM
3 – 30 GPM / 12 – 120 LPM
4 – 40 GPM / 16 – 160 LPM

Accuracy Scale

±5% of Full



Ordering Information¹

W S - 0 8 M 0 8 M - 2 D 5 G - B

Supply Stick

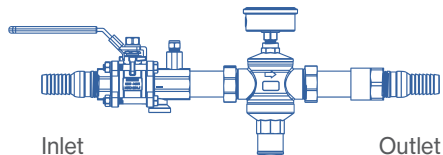

Return Stick

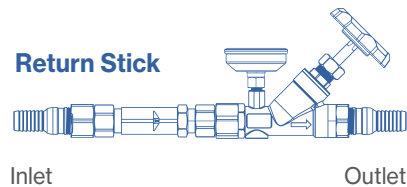

W = Water Stick

S

Type

S = Supply Stick
R = Return Stick

0 | 8

Inlet Size

04 = 1/4"
06 = 3/8"
08 = 1/2"
12 = 3/4"
16 = 1"
24 = 1-1/2"
32 = 2"

M

Inlet Connection

C = Compression
E = Extended Hose Barb
F = Female NPT
G = Flange
H = Hose Barb
M = Male NPT
N = Extended Male NPT
U = Extended Union
V = Extended Union (Compact)²
Y = Union
Z = Union (Compact)²

0 | 8

Outlet Size

04 = 1/4"
06 = 3/8"
08 = 1/2"
12 = 3/4"
16 = 1"
24 = 1-1/2"
32 = 2"

M

Outlet Connection

C = Compression
E = Extended Hose Barb
F = Female NPT
G = Flange
H = Hose Barb
M = Male NPT
N = Extended Male NPT
U = Extended Union
V = Extended Union (Compact)²
Y = Union
Z = Union (Compact)²

2

Inlet Item

X = Not Required

Supply Stick Only

1 = Ball Valve (Oval Handle)
2 = Ball Valve (Lever)

Return Stick Only

3 = Flowmeter

D

Inlet Item Options

P = Pete's Plug®
G = Pressure Gauge
D = Dual Pressure / Temperature Gauge
X = Not Required

5

Outlet Item

X = Not Required

Supply Stick Only

5 = Regulator
6 = Regulator (180° Orientation)

Return Stick Only

4 = Globe Valve

G

Outlet Item Options

P = Pete's Plug®
G = Pressure Gauge
D = Dual Pressure / Temperature Gauge
X = Not Required

B

Flow Meter Range

Horizontal

A = 1 GPM
B = 5 GPM
C = 16 GPM
D = 28 GPM
E = 100 GPM
F = 50 GPM
X = Not Required

Vertical

(connection sizes 1/4" - 1")
K = 10 GPM

Vertical

(connection sizes 3/4" - 1")
L = 20 GPM
M = 30 GPM
N = 40 GPM

¹ Not all possible part number configurations are available. Please contact Valex for availability.

² Used only for 1.5" and 2" union sizes that also have a stainless steel mating end connection.



Benefit From World Leadership

World class components from Valex don't just end at tube, pipe and fittings. Our product offerings extend to ball valves, instrumentation valves, headers, manifolds, and more. For more information, please visit our website at www.valex.com, or contact your Valex representative for details. Benefit from world leadership, and benefit from Valex.

This page was left intentionally blank.





Valex Corporate Offices & Manufacturing

**Valex USA
Corporate Headquarters**

6080 Leland Street
Ventura, CA 93003
United States of America
Phone: 805-658-0944



**Valex USA
Round Rock, TX**

120 E. Old Settlers Blvd.
Round Rock, TX 78664
United States of America
Phone: 512-212-8100



**Valex USA
Georgetown, TX**

1805 Titan Dr.
Georgetown, Texas 78628
United States of America
Phone: 737-340-4600



Valex Korea

32 Hansan-gil, Cheongbuk-eup
Pyeongtaek-si, Gyeonggi-do
Republic of Korea
Phone: 82-31-683-0119



Valex China

No. 358 Zhonggang Road
Xitangqiao Street
Haiyan Economic Development Zone
Zhejiang Province,
P.R. China 314305
Phone: 86-573-86868221

